

MUNDIAL

INDUSTRIAL PLUGS AND SOCKETS

Description: IP66-IP67 WANDER SOCKET 3P+N+E 380V 32A 6H

Reference:

03706

Characteristics:

Product type:	Low voltage wander socket
Current:	32A
Poles:	3P+N+E
Voltage:	200/346 - 240/415 V
Frecuency(Hz):	-
Time code:	6
Colour:	Red
Weight (kg):	1,55
Dimensions:	
Materials:	Halogen-free plastic materials. Plastic parts: polyamide 6. Contacts: copper-zinc alloy
Packaging units:	5

Technical data:

Degree of protection:	IP66-IP67
Degree of protection remarks:	
Resistance to impact:	IK08
Glow wire resistance:	960 °C
Ball pressure test:	125 °C
Ambient temperature range:	-25 °C / +40 °C

Certifications and norms:

Directive:	2014/35/EU
Standards:	IEC 60309-1-2
Certificates:	



Codes:

EAN:	8431044037066
Customs tariff number:	85.36.69.90
ETIM 8.0:	EC001320

MUNDIAL

INDUSTRIAL PLUGS AND SOCKETS

Description: IP66-IP67 WANDER SOCKET 3P+N+E 380V 32A 6H

Reference: 03706

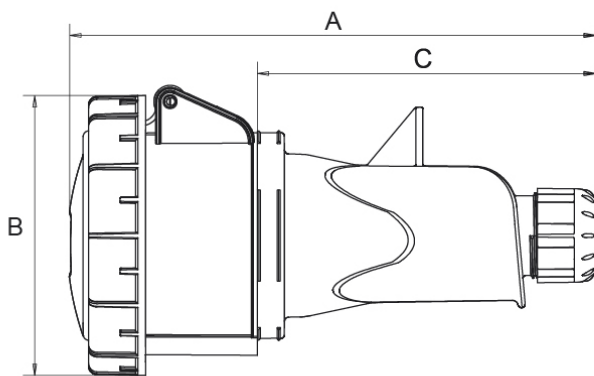

Dimensions:

I	Poles	Dimensions		
		A	B	C
16 A	2P+E	156	69	96
	3P+E	160	77	106
	3P+N+E	172	89	111
32A	2P+E	182	89	111
	3P+E	182	89	111
	3P+N+E	189	98	118
63 A	2P+E	269	114	
	3P+E	269	114	
	3P+N+E	269	114	
125A	2P+E	287	124	
	3P+E	287	124	
	3P+N+E	287	124	

Sustainability:

RoHS - REACH

Product end of life stage:

Product concerned in the WEEE regulations.

Supply:

Supplied in a single box per packaging multiple